



**A588/STL**

**APPARECCHIO DI ILLUMINAZIONE PER ESTERNI CON FISSAGGIO A PARETE**

**DESCRIZIONE:** lanterna e braccio in alluminio pressofuso completi di base per installazione a muro, diffusore in PC anti-UV effetto pioggia, viti in acciaio inox. verniciatura in polvere di poliestere termoidurente

**USI CONSIGLIATI:** giardino, balcone, portico, cortile

**COLORI:** nero, bianco, antracite, canna di fucile, argento-metallizzato disponibile patinato a mano nei colori: ruggine, verde, oro, argento

**COLORI:**

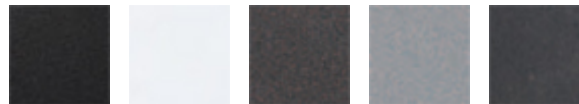

<b>Code</b> A.588/STL	<b>Dimensions (mm)</b> 280 x 500 x 240	<b>Lamp</b> E27 - max 60W	<b>Volume(m<sup>3</sup>)</b> 0,03
--------------------------	---	------------------------------	--------------------------------------

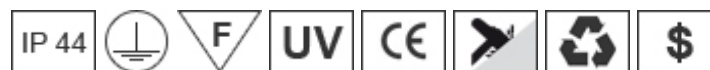



240

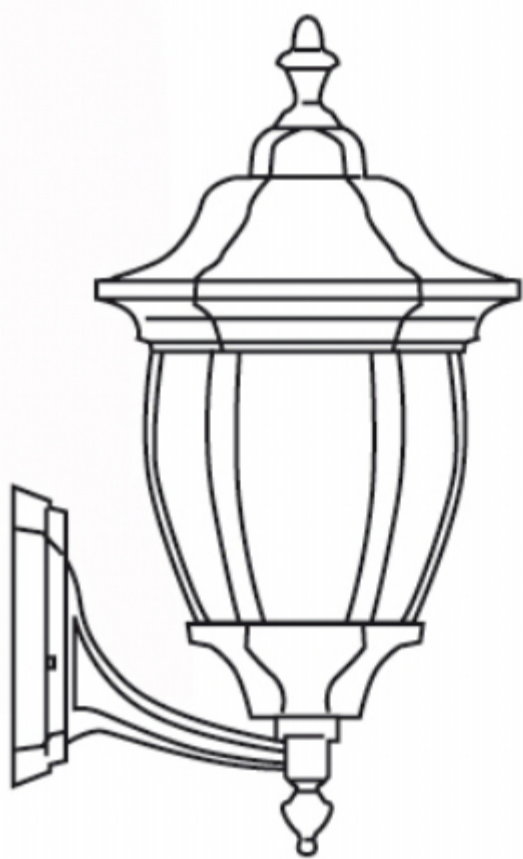
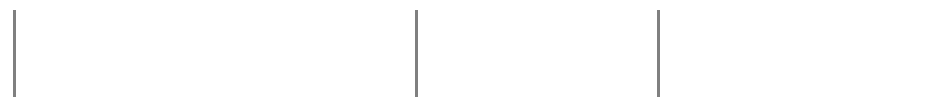
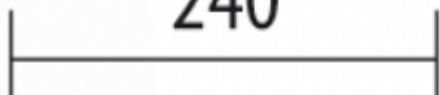

500

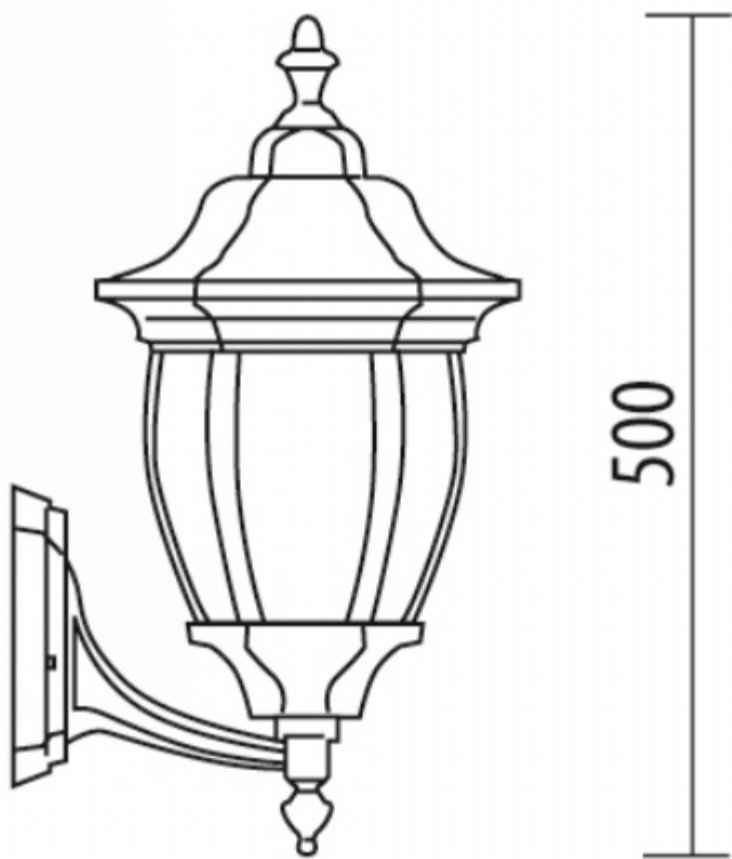

280

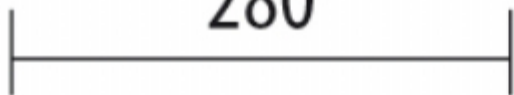

**DURALITE SRL**

Via Brescia, 77 - 25065 Lumezzane (Bs) - Italy Tel. +39 030 871421 Fax +39 030 8976364 - info@duralite.it - www.duralite.it